

ARCHITECTURAL ALUMINIUM GLAZING SYSTEMS

LOUVRE SYSTEMS



K-LOUVAIR

INTRODUCTION

The Kawneer K-LouvAir Ventilation System combines natural ventilation with aesthetically pleasing design solutions. The K-LouvAir provides every building with a comprehensive range of natural ventilation offering a comfortable and healthy indoor climate. The K-LouvAir provides a modern solution for residential buildings, offices, schools and care centres.

The K-LouvAir natural ventilation system has been introduced to suite with the Kawneer window and curtain wall systems offering you a fully integrated system, designed to ensure optimised airflow.

PRODUCT FEATURES AND BENEFITS

- Designed to suite with the Kawneer window and curtain wall systems
- Frame depth 42mm
- Flange width 28/32mm
- Perforated louvre blades resistant to insects, rats and birds
- Stainless steel mesh 2.3mm x 2.3mm as standard
- Option of stainless-steel mesh 6mm x 6mm and 20mm x 20mm
- Option of fibreglass mesh
- Choice of 3 ventilation capacity options all designed to offer a uniform appearance:
 - K1 Small Punching
 - K2 Large Punching
 - K3 False Louvres
- Paint finish to match the Kawneer product range

	K1	K2	K3
Punching			
Resistant to...	Perforated louvre blades as insect screen	Stainless-steel mesh 2.3mm x 2.3mm Standard	100% Unpunched blade
Resistant to...		Stainless-steel mesh 6mm x 6mm Optional	
Resistant to...		Stainless-steel mesh 20mm x 20mm Optional	

K-LOUVAIR



VENTILATION VALUES

Feature	K1	K2
Visual free area	60%	86%
Physical free area	34%	48%
Ce (higher is better)	0,243	0,258
Cd (higher is better)	0,234	0,253
K-Factor (higher is better)	Intake	16,94
	Exhaust	18,26

WATER RESISTANCE

Air Velocity	K1	K2
0 m/s	B	C
0,5 m/s	C	C
1 m/s	C	C
1,5 m/s	D	D
2 m/s	D	D
2,5 m/s	D	D

FRAME TYPES AND DIMENSIONS

	30Z/28 30Z/32
Louvre pitch	37,5mm
Standard frame depth*	24mm, 28mm, 32mm
Flange width	28mm/32mm
Min. dimensions	W 200mm x H 200mm

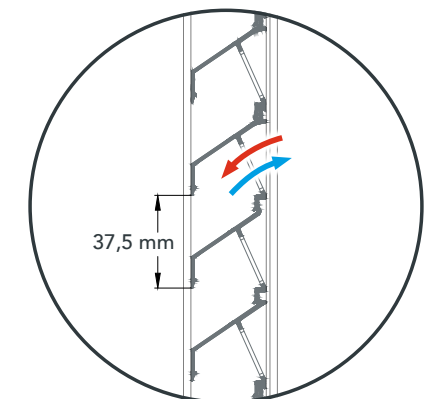

* Larger thickness options available

K-LOUVAIR

VENTILATION CAPACITY

Each louvre is extensively tested and optimised. The range ensures excellent airflow thanks to low resistance.

Air Flow Performance Class	Ce or Cd	Class A	100% - 99%
1	> 0,4	Class B	98,5% - 95%
2	0,3 - 0,399	Class C	94,9% - 80%
3	0,2 - 0,299	Class D	< 80%
4	< 0,199		

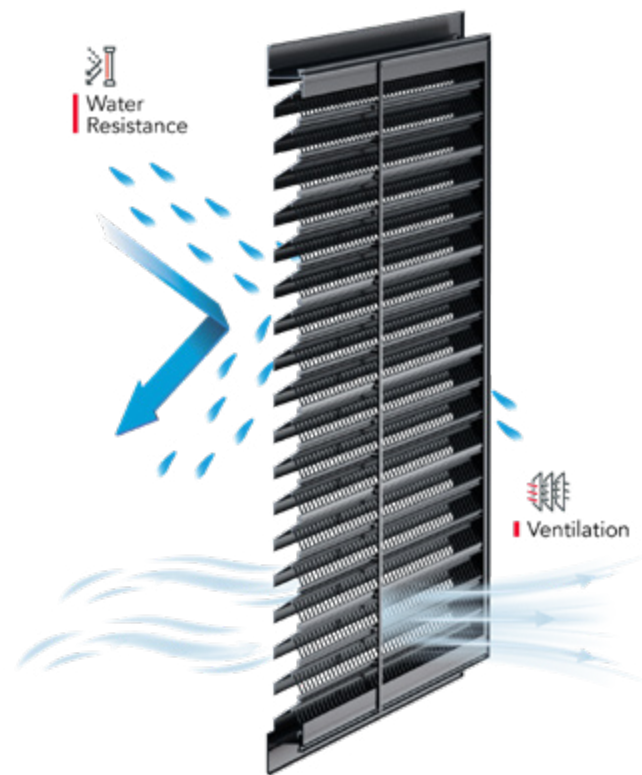

TYPICAL ELEVATIONS

Full details can be downloaded from our website www.kawneer.co.uk

Elevation	Title	Website CAD ref. no.
	1 Louvre in Window Frame - Head Detail	H2.01
	2 Louvre in Window Frame - Cill Detail	H2.02
	3 Louvre in Window Frame - Jamb Detail	H2.03

K-LOUVAIR

Full details can be downloaded from our website www.kawneer.co.uk

HEAD DETAIL

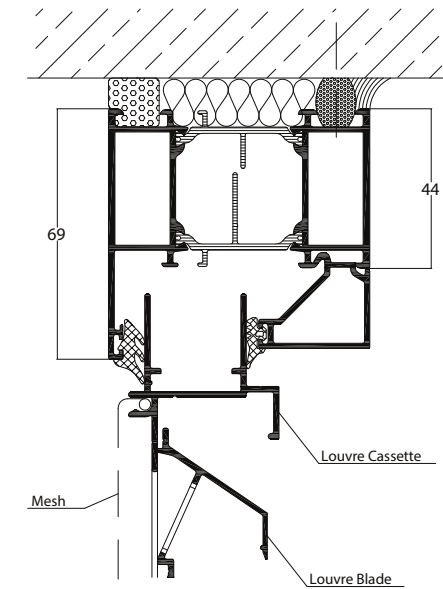

H2.01

JAMB DETAIL

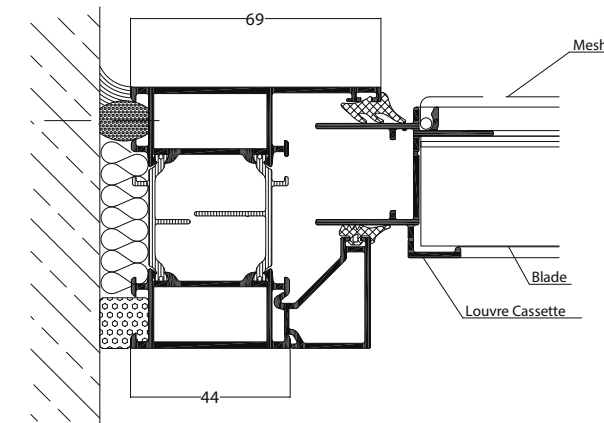

H2.03

CILL DETAIL

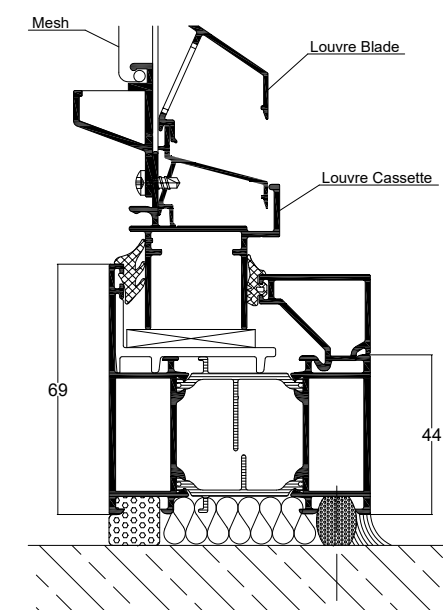

H2.02

K-LOUVRESHIELD

INTRODUCTION

K-LouvreShield is designed to suite with Kawneer's KWD92 UT+ and AA®720 Open-In Windows. It offers a simple and aesthetic solution for providing both ventilation and fall protection and is ideally suited for domestic, residential (including student accommodation), retail and commercial applications.

It is surface mounted onto the outer frame of the window and allows free air movement into the room when the windows are operated in either the tilt or turn modes. Additionally, the louvre can function as a safety barrier when the windows are operated in the turn mode and if conditions dictate that fall protection is required.

Two blade options are available to suit specific building requirements and increase the aesthetics of the façade.

K-LouvreShield is a totally self-contained solution that completely eliminates the need for additional sub-contractor work and does not interface with any other element of the building structure.

K-LouvreShield has been fully tested in accordance with BS 6180 (Barrier Loading) to 1.5 kN/m Line Load and with BS EN 13049 (Impact Resistance) achieving Class 5.

PRODUCT FEATURES AND BENEFITS

- Suites with the KWD92 UT+ and AA®720 Open-In Windows
- Louvre spacing to meet specific free area requirements
- Fall protection
- Two blade options available for increased aesthetics of the façade
- A wide range of polyester powder paint finishes with up to 30 years guarantee and a range of anodised finishes with up to 25 years guarantee
- Glazing systems and Louvres from one manufacturer, offering design flexibility and total project solutions

PERFORMANCE

K-LouvreShield, installed to Kawneer specifications, has been tested and certified in accordance with:

BS 6180 Line Load and Point Load

- Line Load: 1.5 kN/m

- Point Load: 1.5 kN

BS EN 13049 Impact Testing

- Impact Test: Class 5 (drop height 950mm)

CONSTRUCTION

K-LouvreShield consists of a cleated and pinned perimeter frame. The louvre blades are screw splined for mechanical fixing to the perimeter frame. Clip covers are used to conceal all fixings. K-LouvreShield assembly is screw fixed to the window outer frame.



K-LOUVRESHIELD

TYPICAL ELEVATIONS

Full details can be downloaded from our website www.kawneer.co.uk

Elevation	Title	Website CAD ref. no.
	1 Louvre to Frame - Horizontal Sections	H02.01, H05.01
	2 Louvre to Frame - Head, Vertical Sections	H03.01, H06.01
	3 Louvre to Frame - Cill, Vertical Sections	H04.01, H07.01
	1 Rectangular Louvre (Guarding) - Vertical Section	H08.01
	1 Rectangular Louvre (Non Guarding) - Vertical Section	H09.01
	1 90mm Sloped Louvre (Guarding) - Vertical Section	H10.01
	1 90mm Sloped Louvre (Non Guarding) - Vertical Section	H11.01



Quayside House, Gloucester
Architect: ADP Architecture

K-LOUVRESHIELD

Full details can be downloaded from our website www.kawneer.co.uk

RECTANGULAR LOUVRE BLADE – GUARDING

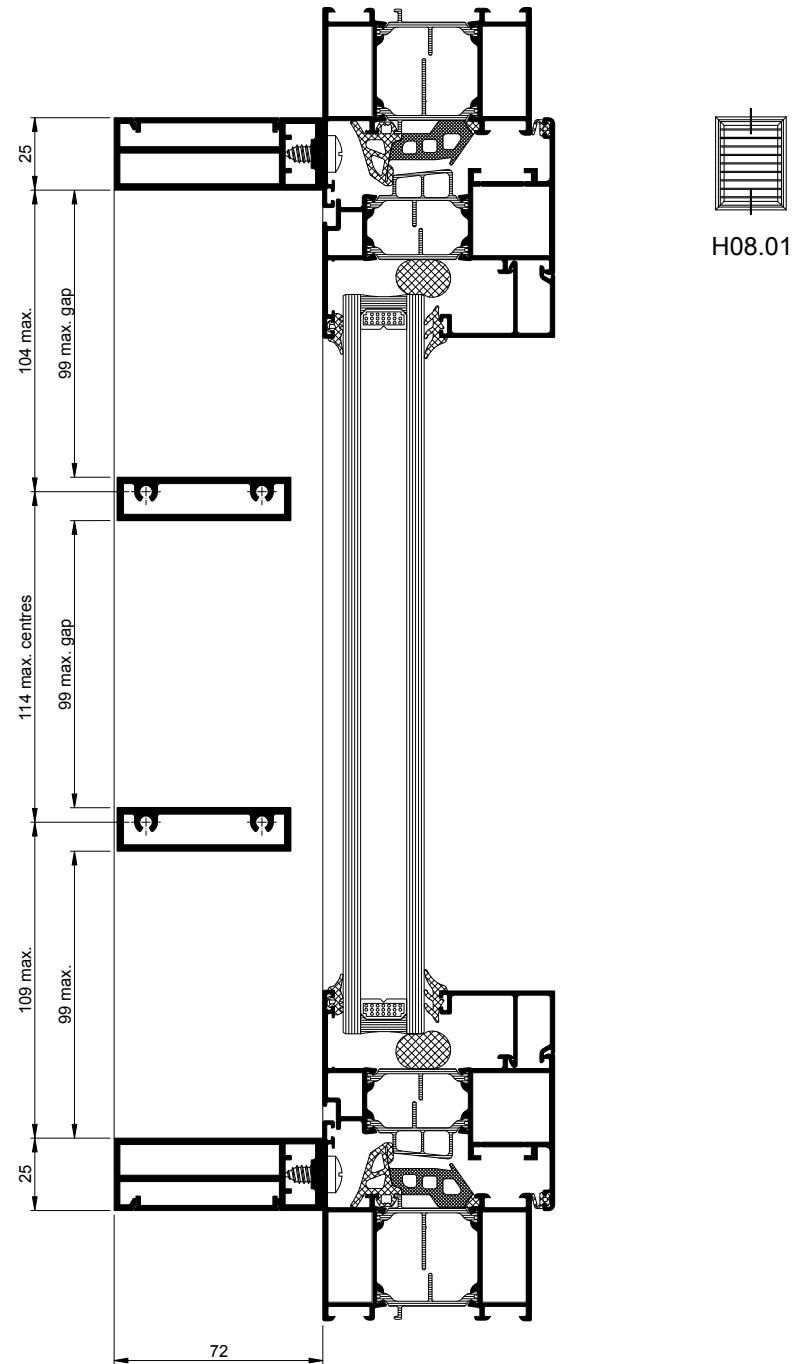

K-LOUVRESHIELD

Full details can be downloaded from our website www.kawneer.co.uk

90MM LOUVRE BLADE – GUARDING

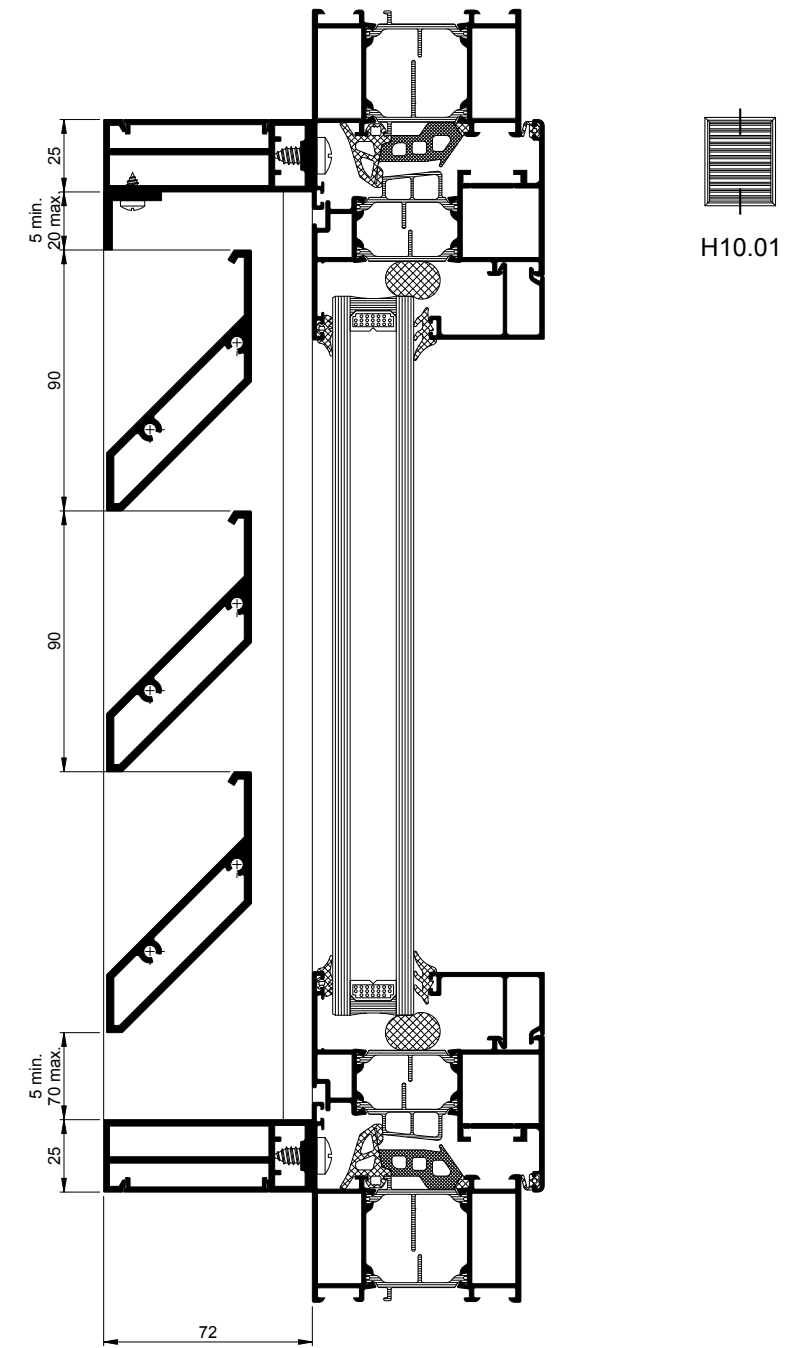

K-LOUVRESHIELD

For increased aesthetics to the façade of your building, two blade options are available. See the assembly illustrations below for the Rectangular Louvre Blade and the 90mm Louvre Blade.



Rectangular Louvre Blade Assembly

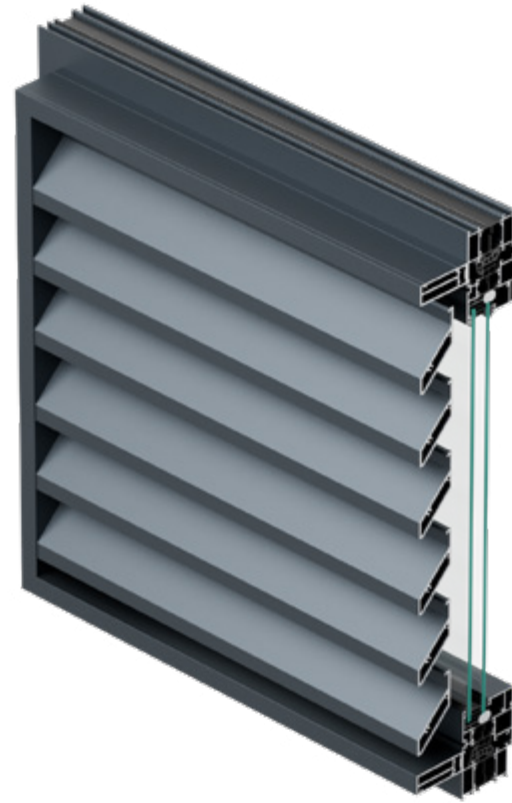

90mm Louvre Blade Assembly

SUPPORTING YOUR PROJECTS

A FULL RANGE OF GUARANTEED COLOURS AVAILABLE*

Established in the UK for over 60 years and powder coating profiles at its Runcorn base for 50 years, Kawneer has deep knowledge and experience in the specification and application of colour and paint systems.

The existing powder coating facility was converted to 'chrome free' – the first existing plant in the UK to be upgraded to this environmentally friendlier pre-treatment system – which gave Kawneer additional impetus to become a QUALICOAT approved applicator.

Quality and consistency of quality continues to be the main feature of QUALICOAT UK & Ireland, which includes third party testing of all certified powder formulations and pretreatment systems that make up the QUALICOAT approval process. Kawneer has achieved 'Seaside' specification standard with this third party accreditation programme.

Kawneer Permacover™ is a high quality polyester powder paint finish, offering a wide range of solid and metallic colours providing outstanding resistance to environmental conditions. Kawneer Permacover™ has a 15 year gloss and 30 year matt and metallic guarantees subject to application and Kawneer acceptance in marine, industrial, swimming pools or other aggressive atmospheres.

To ensure the highest quality finish, powder coating is carried out in house as part of our single-source responsibility.

Kawneer Permanodic® is a range of subtle anodised colours which have been specifically developed for architectural glazing systems. Kawneer Permanodic® is a tried and tested anodising process, proven in accelerated laboratory tests, extensive field trials and contract experience. Subject to compliance with Kawneer's requirements, a 25 year finishes guarantee can be obtained.

AUTHORITIES*

ISO 9001
Quality Management System

BS EN 12020
Extruded precision aluminium profiles

BS EN 12206-1
Paint and varnishes. Coating of aluminium and aluminium alloys for architectural purposes

BS 3987
Specification for anodic coatings

BS 6180
Barriers in and about buildings – Code of practice

BS EN 13049
Soft and heavy body impact – Test method, safety requirements and classification

BS 6262-4
Glazing for buildings – Part 4: Safety related to human impact – Code of practice

BS 6206
Impact Performance requirements for flat safety glass and safety plastics for use in buildings.

PROJECT ASSISTANCE

Kawneer's regionally based team of Architectural Advisers and the Architectural Services Team based at our Head Office in Runcorn are able to provide project advice and support:

Tel: 01928 502604
Email: kawneerAST@arconic.com

Information on Kawneer's extensive range of Curtain Wall, Window, Framing, Door, Fire Resistant and Sliding Solutions can also be obtained from our Head Office by calling:

Tel: 01928 502612

Kawneer UK Ltd is part of Building and Construction Systems, and enjoys the extensive resources of the entire Kawneer organisation, allied to the specific glazing systems experience of Kawneer's many operations around the world. As a result of this our partners and customers have direct access to one of the largest pools of technical expertise in the construction industry.



* K-LouvreShield Only

OTHER BROCHURES AVAILABLE ON REQUEST FROM KAWNEER ARE:

- Finishes
- Door Systems
- Framing Systems
- Curtain Wall Systems
- Unitised Curtain Wall Systems
- K-Vantage Systems
- Sliding Solutions
- Fire Resistant Systems
- Window Systems
- Passive House Façade Solutions
- Suited Handle Range
- Sustainability
- Maintenance and Cleaning
- Education
- Residential
- Perspectives
- The Architects Guide to Aluminium in Building

To download these brochures please visit www.kawneer.co.uk

Front Cover: Cardiff Bus Interchange
Architects: Holder Mathias and BDP
Photo: BDP/Nick Caville

October 2024



Kawneer's continuous development and engineering programmes may bring about product changes. Kawneer reserves the right to introduce without notice such changes which will not detract from the product's performance.

© KAWNEER UK LTD



Kawneer UK Ltd
Astmoor Road
Astmoor Industrial Estate
Runcorn
Cheshire
WA7 1QQ
United Kingdom
Tel: +44 (0) 1928 502500

London Office
12 Berwick Street
Soho
London
W1F 0PN
Tel: +44 (0) 207 287 5911

Architectural Services Team
Tel: +44 (0) 1928 502604
Email: kawneerAST@arconic.com
www.kawneer.co.uk